

Pneumatic Oilpump 3:1

Operating Instructions

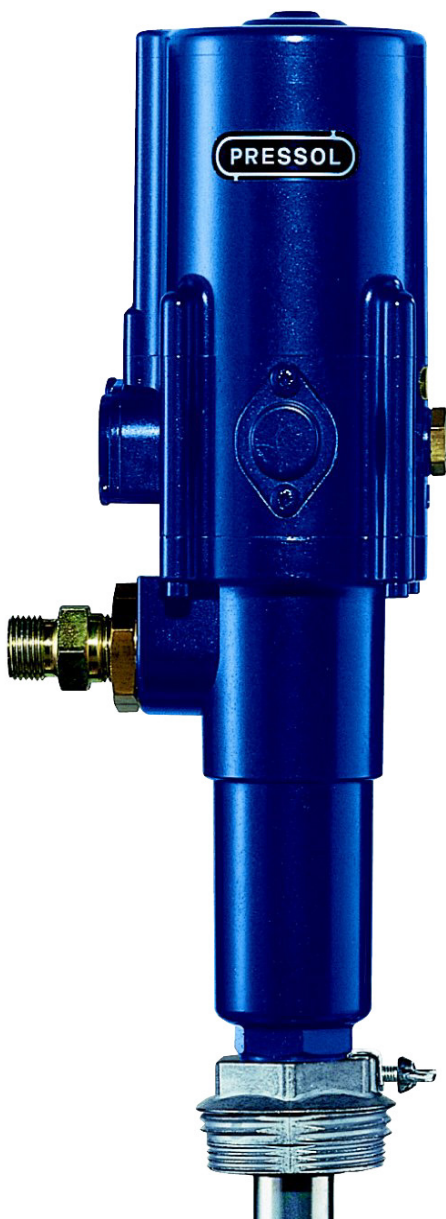



Contents:

- 1. General Information**
 - 1.1 Usage Stipulations
 - 1.2 Construction & Functional Description
 - 1.3 Technical Data
 - 1.4 Application Range
 - 1.5 Operational Area Requirements
- 2. General Safety Advice**
 - 2.1 Safe Working Advice
 - 2.2 Risks when Working with the Oil Pump
- 3. Assembly**
 - 3.1 Barrel- and Tank Mounting
 - 3.2 Wall Mounting
- 4. Preparing for Operation**
 - 4.1 Venting the Pump and Installation
- 5. Operation**
 - 5.1 Changing a Barrel
- 6. Maintenance**
- 7. Accessories**
- 8. Fault Finding**
- 9. Repairs/Service**
- 10. EC Declaration of Conformity**
- 11. Exploded view**

Explanation of Safety Advice

The safety advice provided in these operating instructions is categorised according to different danger levels. The different danger levels are identified within the instructions by the following symbols and identifying words:

Symbol	Indicates	Result if the safety requirements are not observed or applied
	Danger	Death or very serious injury
	Warning	Possible death or serious injury
	Caution	Possible slight or not serious injury or material damage

Tab. 1-1: Safety Advice Classification according to Danger Type and Severity

In addition, another symbol is used to indicate general advice about using the product.

Symbol	Indicates	Meaning
	Note	Background information or advice about how to use the product

Tab. 1-2: General Information



If the oil pump is incorrectly installed, or used for a purpose other than that originally intended for, it can result in personal injury or damage to equipment!

Before starting to use the oil pump, read through these operating instructions carefully and completely.

1. General Information

1.1 Usage Stipulations

- This oil pump can be used to deliver lubricating oil and similar neutral fluids.



Danger!

Never use it to deliver explosive fluids such as petrol, or other fluids with similar flashpoints!

- To ensure that usage stipulations are met, read through the operating instructions completely before using the pump and observe all stipulations.

- Any departure from the usage stipulations (other fluid media, use of force) or user modifications (changes, use of non-original parts) can be dangerous and are considered as non-stipulated usage.
- The user is liable for any damage resulting from non-stipulated use.
- Before commencing any repair or maintenance work, release the pressure from the installation.
- Repairs and maintenance are only to be carried out by qualified specialists.
- Only original replacement parts are to be used for any repairs, otherwise the warranty will be invalidated.

1.2 Construction & Functional Description

- The oil pump can be fitted with a variety of PRESSOL accessories.
- The Pump casing is manufactured from die-cast zinc with a hardened stainless steel piston rod and high quality durable synthetic control components.
- The polyurethane or Buna N o-rings and washers are designed to meet the operating requirements of the pump.

1.3 Technical Data

Typ		3:1
Year of Production		See Identification Plate
Ratio		3:1
Max. Air Pressure	bar	10
Recommended Air Pressure	bar	8
Min. Air Pressure	bar	2
Max. Oil Pressure	bar	30
Max. Delivery Performance*	L / min	20
Max. Air Consumption.	L / min	450
Air Inlet	G	¼" i
Oil Outlet	G	½" a
Piston Diameter	mm	80
Piston Stroke	mm	44
Motor Displacement	cm ³	220
Pump Displacement	cm ³	70
Max. Sound Level at 2 m	Db (A)	78
Wight	kg	7,2
* under free discharge		

Tab. 1-3: Technical Data

1.4 Recommended Applications

This pump was developed for pumping diesel, motor, and hydraulic oil as well as low-viscosity and selflubricating mediums. The pump is recommendable for use in pipe systems together with a hose reel. Even with a 15 m hose, delivery meter and anti-drip nozzle, the pump still has a very high delivery performance. The delivery performance is dependent upon the viscosity of the oil, the temperature as well as the length and the cross-section of the piping. The pump will also operate in non-vertical installations.

1.5 Operational Area Requirements

The operator of such an installation is, according to § 19i WHG (Germany) responsible for continuous monitoring to ensure compliance with the above stated requirements at the installation.

The oil pump is intended for use within a building. The installation area must be selected such that correct operation is ensured.

To avoid unnecessary damage and to prolong the life expectancy of the pump we recommend that an air line combination filter, regulator and lubricator is utilised to ensure that the compressed air supply is not contaminated and is regulated at the recommended pressure.

New installation lines should be cleaned to avoid any residual metal filings damaging individual components within the pump. When changing containers protect the suction tube properly to make sure that the suction tube will not be contaminated by dirt particles, such as metal parts, splinters etc. which will additionally contaminate the lubricant in a new container.

To make service and maintaining work easier we recommend the installation of a lever ball valve placed between the oil connecting hose and the fixed oil distribution pipe work.

Um Reparaturen oder Servicearbeiten leichter durchführen zu können, empfehlen wir einen Kugelhahn zwischen Druckschlauch und Öldruckleitung zu montieren.

2. General Safety Advice

2.1 Safe Working Advice

- The oil pump has been designed and manufactured according to the health and safety requirements of the relevant EC guidelines.
- Nevertheless, there can still be risks if the product is not set up or operated as stipulated.
- Therefore, before using the oil pump, read these operating instructions and pass them on to other users of the pump.
- When operating the oil pump, the local safety and accident prevention rules and regulations always apply, as well as the safety advice in the operating instructions.
- Only approved PRESSOL maintenance personnel should open or repair pumps within the guarantee period.

WARNING! The compressed air line must be disconnected and the discharge pistol actuated to ensure so the pump is depressurised before the pump unit is opened or inspected. For safety reasons the compressed air line should be disconnected when the pump is not in use otherwise the pump will remain pressurised.

2.2 Risks when Working with the Oil Pump



Warning!

Never work on a pump that is running!

- Mount or remove attachments and accessories only when the pump is switched off.



Warning!

Do not pump contaminated fluids!

- Take special care to ensure that there is no contaminant in the fluid to be pumped.
- Install a strainer on the suction pipe.



Warning!

Damaged attachments and accessories can lead to personal injury and material damage!

- Suction and pressure pipes must not be kinked, twisted or stretched.
- The pressure-side installation of an overflow valve is recommended (see accessories).
- Attachments and accessories must be checked for wear, splits or other damage at all times.
- Damaged attachments and accessories must be replaced immediately.
- With reference to the period of use, please note the details in ZH 1/A45.4.2 or DIN 20066 Part 5.3.2.



Caution!

Spilled fuel can result in environmental damage

- Local and country rules and regulations relating to domestic water supplies and fuel storage must be obeyed.

3. Assembly

- The oilpump can be used for oil supply out of original drums or out of oil storage tanks.



Note

An upward installation of the suction line is recommended according to European regulation. Consider before assembly the height of the container used and in case of necessity the use of an oil container storage unit..

3.1 Barrel- and Tank Mounting

- Fix pump and suction tube using the G 2" drum retention adapter on the container or on the storage tank.
- Connect the discharge hose to the pump connecting adapter G 1/2".
- Connect the discharge valve or the manual flow meter to the discharge hose.

3.2 Wall Mounting



Note

When installing the 3:1 oil pump in connection with long distribution lines we recommend the use of a foot valve

To avoid possible overpressures in the pump we recommend in any case the installation of a foot valve with an overpressure releasing drill hole (art.no. 03337).

- For fixation of the oil pump we require 2 screws with a diameter of 10 or 12 mm (not included in the product package) Choose screws corresponding to the wall material, on which the pump shall be mounted.
- Take care for a stable wall mounting of the pump. Take care for a protected mounting location, protecting i.e. against splash water,
- Please mount the calibratable pump for a trouble-free operation of the integral air eliminator in an upright position, only.
- Fix suction tube using the G 2" drum retention adapter on the container or on the storage tank.
- Connect suction tube and pump with suction hose (hose connection G 3/4")
- The air- and oil back-flow tube of the calibratable pump version shall be lead back into the container or tank utilizing the drilled hole in the drum adapter.
- Connect oil pump with control valve or manual flow meter and oil discharge pipe work with a discharge hose.
- Installation material for discharge pipe work
 - Length of discharge pipe work up to 15 m: Pipe work tube DN 20 (R 3/4") DIN 2448 or bigger; St 37 acc. to DIN 1629.
 - Length of discharge pipe work exceeding 15 m: Pipe work tube DN 32 (R 1 1/4") DIN 2448 or bigger; St 37 acc. to DIN 1629.
- Overflow valve (see accessories).
- Lever ball valve (see accessories).



Note

Pay attention to a correct installation and to an accurate connection of the accessories with the pump

Use suitable sealing material in any case. (i.e. Teflon-tape).

- The pump is now ready for operation.

4. Preparing for Operation

4.1 Venting the Pump and Installation

- Connect Pump with compressed air (6 bar recommended)
- Open the farthest control valve of the installation supported by a oil collecting tray until oil will be discharged completely air-less.
- Repeat this procedure on any point of discharge of the installation.

5. Operation



Note

To ensure that the tank can be completely emptied, the suction hose must reach to the bottom of the tank.



Caution!

Never operate the pump without delivery fluid. There is a danger of your oil pump being damaged if operated dry.



Caution!

Shut-off the compressed air line, when the oil supply system is not needed for a longer time in any case.

- Start the pump with compressed air, the oil supply system is ready for operation.
- The pump switches on and starts to discharge when opening the control valve.
- When closing the control valve the pressure in the oil system will increase forcing the pump to come to a stillstand.

5.1 Changing a Barrel

- You can avoid contamination by inserting the suction line directly into the new oil container.

6. Maintenance

The muffler and air inlet filter should be cleaned regularly to maintain the trouble free performance of the pump. If an air line lubricator has not been installed frequently lubricate the pump by inserting 2 to 3 drops of quality oil through the air inlet connector at regular intervals.

The oil pump is very easy to maintain and service.

Due to the operator responsibilities according to § 19i WHG (German rules), the following components must be regularly checked and replaced as necessary, to minimise the possibility of environmental or equipment damage, or personal injury:

- Pump housing
- Delivery hose
- Nozzle valve
- Connection lines

7. Accessories

- Dual-Suction pipe, 2 m, No. 19 511
- Suction pipe, for oil, 2 m, G ¾" i, G ¾" o, No. 19 512
- Suction tube, G ¾" i, G 2" o, SRL 860, for 200/220 l container, No. 19 522
- Suction tube, G ¾" i, G 2" o, SRL 860, for 200/220 l container, with foot valve, No. 19 523
- Suction tube, G ¾" i, G 2" o, SRL 1600, for tank mounting, with foot valve, No. 19 523 001
- Conversion set, SRL 860, for 200/220 l container, No. 19 513 950
- Conversion set, SRL 1600, for tank mounting, No. 19 513 952
- Conversion set, SRL 1600, for tank mounting, 90° connector for connecting to Pneumatic-Pump, No. 19 513 954
- Suction tube, G ¾" i, G 2" o, SRL 2100, for tank mounting, with foot valve, No. 19 523 954
- Wall mounting bracket, No. 19 521
- Maintenance unit, No. 20 218 950
- Coiled hose 5 m, No. 20 185
- Lever ball valve G ¾" i - G ¾" i, No. 19 763
- Lever Ball valve G ¾" i - G ¾" i, No. 19 762
- Discharge hose 0,5 m G ½" i - G ½" i, No. 19 580 001
- Foot valve G ¾" i, No 03 337
- Discharge hose 1,5 m G ½" i - G ½" i, No. 19 580
- Overflow valve 16 bar, No. 19 648
- Overflow valve 20 bar, No. 19 506



Note

Only with original-PRESSOL spare parts is perfect operation of your oil pump guaranteed! To avoid faulty operation and danger, please use only original spare parts.

8. Fault Finding

Fault	Cause	Solution
The air motor runs slowly or not at all.	The air pressure is too low.	Regulate the air supply at a minimum pressure of 3 bar.
	The muffler (pos. 20) or the filter (pos. 11) is obstructed or dirty.	Clean the muffler and filter.
The air motor is running but the pump is operating too slow or not at all.	Leak in the suction pipe.	Repair the hole.
	Air in the delivery pipe.	Remove the air bay: a) Pressing the discharge pistol after removing the anti-drip-nozzle. b) Slightly opening the delivery pipe immediately behind the pump.
	Oil is too cold.	Only use oil with a temperature over 15° C.
	Friction loss in the delivery hose.	Choose (as far as possible) large cross sections and short pipe distances. Place the pump in a central position.
The air motor is running but no pressure is generated.	The o-rings, washers or valves of the pump are damaged or dirty.	Clean or replace the relevant components.
Air escapes from the muffler when the pump is not operating.	The plunger (pos. 5) is damaged.	Replace the plunger.
	The o-rings or the distributor seal (pos. 19.6) are damaged.	Replace the components utilising the complete repair kit. Article number 72097

Tab. 8-1: Fault Finding

If the solutions given in Tab. 8-1 for solving faults do not solve the problem, please contact our customer service (Address, See Chap. 9).

9. Repairs/Service

The oil pump was developed and produced according to the highest quality standards.

Should a problem develop, despite all quality controls, please contact our customer service:

Customer Service/Repair Department

PRESSOL Schmiergeräte GmbH

Tel. +49 911 32 441-35 • Fax +49 911 32 441-65 • export@pressol.com

10. EC Declaration of Conformity

We hereby declare that the product described here, its concept and construction, including this particular model, complies with the EC requirements. Any change to the product, not approved by us, will invalidate the declaration.

Product Description:	Pneumatic pump 3:1
Product Type:	Pneumatic pump
Year of Manufacture:	See identification plate
Applicable EC-Directives:	EU-Directive Machines annex 1 89/392 EEC-Directive dated September, 14th. 1989 91/368 EEC-Directive dated June, 6th. 1991 , 93/68 EEC-Directive dated August, 30th. 1993
Applicable National Standards:	DIN EN 292, part 1, part 2 DIN EN 45014

19.10.2009

PRESSOL Schmiergeräte GmbH

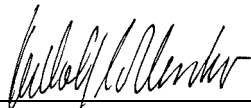

Dipl.-Ing. Rudolf Schlenker

11. Exploded view

No.	Description	Article number
1	Upper Casing	03 268
2	O-Ring	03 316
3	Locking Nut	03 311
4	Washer	87 116
5	Plunger	03 324
6	Compensating Washer	03 250
7	Screw	87 221
8	Washer	87 212
9	O-Ring	02 380
10	Intermediate Casing	87 211
11	Filter	87 228
12	Reducing Connector	03 319
13	Control Lever	87 210
14	Sleeve	87 209
15	Compression Spring	87 215
16	O-Ring	87 223
17	Insert	87 206
18	Screw	87 220

No.	Description	Article number
19	Distributor Repair Kit	87 351
19.1	Clamp	87 214
19.2	Sliding Disc	87 213
19.3	O-Ring	87 225
19.4	O-Ring	87 224
19.5	O-Ring	87 223
19.6	Distributor	87 204
20	Muffler	87 227
21	Retainer	87 207
22	Piston Rod Repair Kit	87 353
22.1	O-Ring	03 262
22.2	Piston Rod	87 205
22.3	Slider	87 208
22.4	Piston Rod	02 843
23	O-Ring	87 226
24	Connecting Flange Repair Kit	87 217
25	Screw	87 222
26	Connecting Flange Repair Kit	87 656
26.1	O-Ring	88 164
26.2	O-Ring	88 165
26.3	Adapter	88 152
26.4	O-Ring	02 380
26.5	Lip Washer	03 387
26.6	Circlip	03 264
27	Pump piston	02 844
28	Compression Spring	02 851
29	Ball	03 263
30	O-Ring	87 521
31	Valve screw	87 646
32	Sleeve	03 390
33	Locking Pin	87 630
34	Locking Nut	01 085
35	Valve washer	03 416
36	O-Ring	02 849
37	Pump Cylinder	02 854
38	Compression Spring	02 852
39	Valve rod	03 336
40	Washer	02 853

Tab. 11-1: Index to illustration 11-1

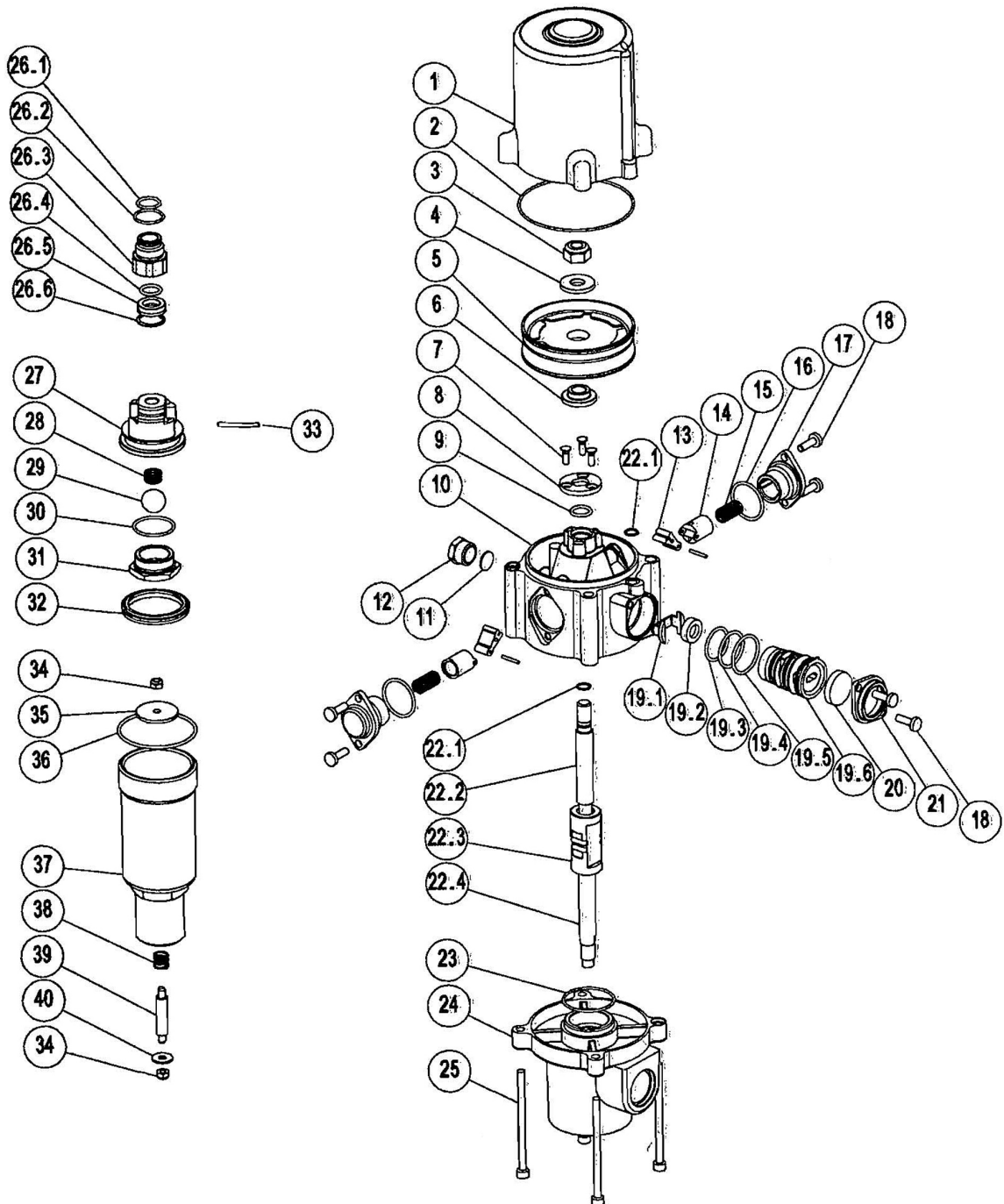

Fig. 11-1: Exploded View of the Pneumatic Oil Pump

PRESSOL Schmiergeräte GmbH • Parkstrasse 7 • D-93167 Falkenstein

Tel. +49 9462 17-0 • Fax +49 9462 17-208 • info@pressol.com • www.pressol.com